

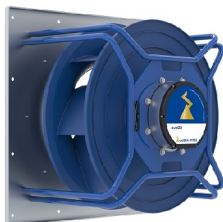

1



GR45C-ZIK.DC.CR | 116251/A01 | Portfolio STD-WW | Cpro ECblue

### Standard design with ECblue motor and integrated electronics

#### Material of impeller:

- ZAmid - high performance composite material

#### Color Coating:

- Color coating in RAL5002 (Ultra marine-blue)

#### Mains voltage motor size B\_:

- 1~ 200...277 V; 50/60 Hz

#### Mains voltage motor size D\_:

- 1~ 200...277 V; 50/60 Hz
- 3~ 200...240 V; 50/60 Hz
- 3~ 380...480 V; 50/60 Hz

#### Mains voltage motor size G\_:

- 3~ 200...240 V; 50/60 Hz
- 3~ 380...480 V; 50/60 Hz

#### Thermal class:

- THCL155

#### Thermal protection:

- Protection with active temperature management

#### Protection:

- IP55

#### Coating:

- Motor painted in RAL5002 (Ultra marine-blue)

#### Controller (only motor size B\_):

- Activation via external speed setting 0-10 V / PWM, Communication interface on request
- Standard cable length: 60 cm

#### Controller (only motor size D\_, G\_):

# FANselect



- **BASIC:**

Activation via external speed setting 0-10 V / PWM Art. no. ER- and GR-module  
in basic version

- **PREMIUM:**

Integrated control functionality, Communication interface on request

**Cable glands:**

- Motor size D: 3 x M16 x 1.5
- Motor size G: 3 x M20 x 1.5

**Ambient temperature:**

- Minimum permissible ambient temperature: -20 °C\*
- Maximum permissible ambient temperature: 40 °C or see data sheet

**\*Continuous operation with occasional starts (S1) according to DIN EN 60034-1: 2011-02. Occasional starting between -35 ° C and -25 ° C is permissible. Permanent operation below -25 ° C only possible with special bearings for refrigeration applications on request.**



## fan data

15/12/2021

version FANselect V 1.01 (211209), AMCA V 1.03 September, 2021 / 1.21.12.09 | 53567 | (user ZAFS43567)



type	GR45C-ZIK.DC.CR
article no.	116251/A01   Portfolio STD-WW

## technical data

motor	ECblue	
Efficiency class	IE5	
mains supply	-	3~ 400V 50Hz
ambient temperature, max. limit ( $t_r$ )	°C	40
efficiency grade $\eta_{statA}$	%	69,3
efficiency grade $N_{actual}$   $N_{target}$		77,1   62
ErP-conformity		2015   EC controller integrated
grille   influence		no

## fan data

SFP-class   SFP-value ( $P_{SFP}$ )	-   Ws/m <sup>3</sup>	3   1157
airflow volume ( $q_v$ )	ft <sup>3</sup> /min	3267.3
air velocity	ft/s	26.49
pressure, stat. ( $p_{sF}$ )   tot. ( $p_F$ )	in.wg.	2.978   3.129
electrical power input ( $P_{sys}$ )	W	1785
system eff., stat. ( $\eta_{sF,sys}$ )   tot. ( $\eta_{F,sys}$ )	%	64.1   67.3
fan speed ( $n$ )   max. ( $n_{max}$ )	rpm	1800   1800
fan speed, set value (% $n_{max}$ )	%	100
frequency ( $f_{BP}$ )   ( $f_{max}$ )	Hz	50   60
voltage ( $U_{DP}$ )	V	400
current ( $I_{DP}$ )	A	2.74
acoustics, suction side ( $L_{w(A),5}$ )   ( $L_{w,5}$ )	dB	75   80
acoustics, pressure side ( $L_{w(A),6}$ )   ( $L_{w,6}$ )	dB	81   85
dimensions (w x h x d)	in	23.62 x 23.62 x 14.61
product weight ( $m_{pr}$ )	lb	72.8
k-factor nozzle pres. (k)	-	197
differential pres. nozzle ( $p_{sF \text{ nozzle}}$ )	Pa	794

PF:PF\_50; Ano:116251; STot:+-10 %





# FANselect

## performance curve / acoustics

15/12/2021

version FANselect V 1.01 (211209), AMCA V 1.03 September, 2021 / 1.21.12.09 | 53567 | (user ZAFS43567)

- 1 **GR45C-ZIK.DC.CR** measured in standard nozzle in installation type A according to ISO 5801  
 116251/A01 | Portfolio measurement density 0.072 [lbs/ft<sup>3</sup>]  
 STD-WWW

### air performance $p_{sF}$

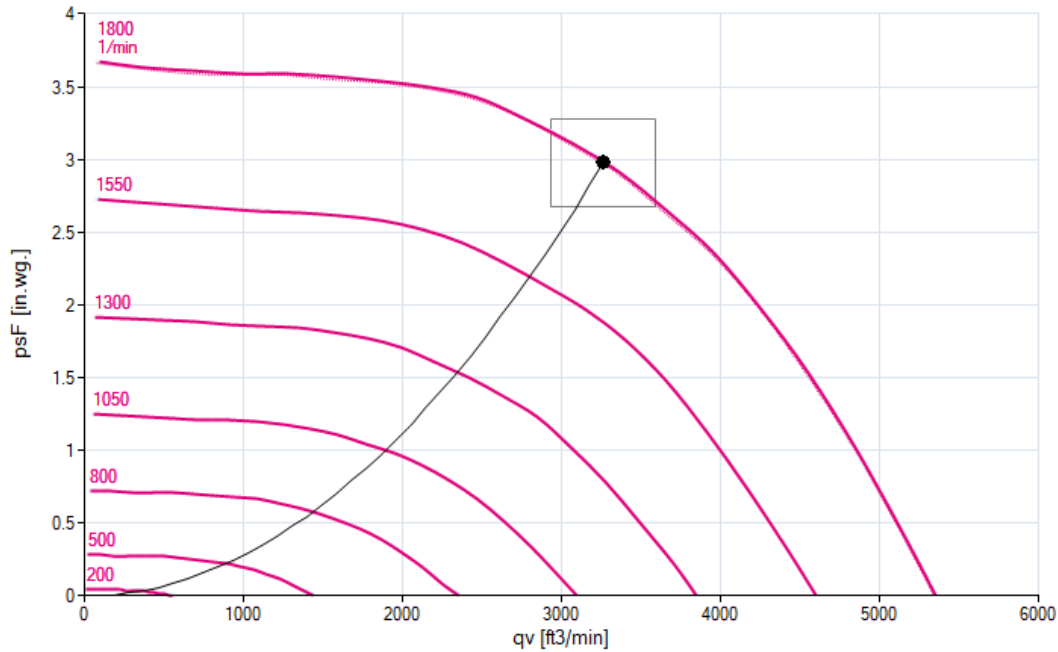

### acoustics ( $L_{w(A),5}$ )

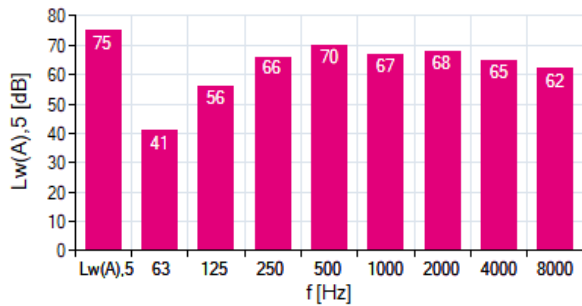

### acoustics ( $L_{w(A),6}$ )

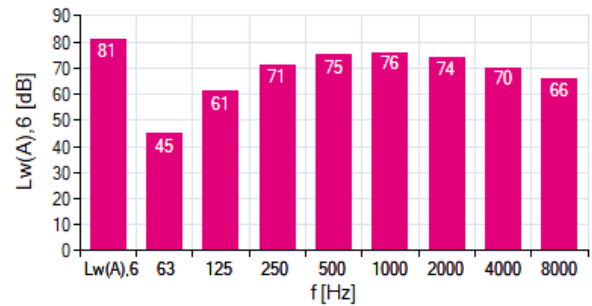

1 GR45C-ZIK.DC.CR									
f [Hz]	sum	63	125	250	500	1000	2000	4000	8000
$L_{w(A),5}$	75	41	56	66	70	67	68	65	62
$L_{w,5}$	80	67	71	76	74	67	67	64	62

f [Hz]	sum	63	125	250	500	1000	2000	4000	8000
$L_{w(A),6}$	81	45	61	71	75	76	74	70	66
$L_{w,6}$	85	71	75	81	78	76	73	69	67

# FANselect



efficiency grade / power input 15/12/2021  
version FANselect V 1.01 (211209), AMCA V 1.03 September, 2021 / 1.21.12.09 | 53567 | (user ZAFS43567)

- 1 **GR45C-ZIK.DC.CR** measured in standard nozzle in installation type A according to ISO 5801  
116251/A01 | Portfolio measurement density 0.072 [lbs/ft<sup>3</sup>]  
STD-WW

efficiency grade  $\eta_{F,sys}$

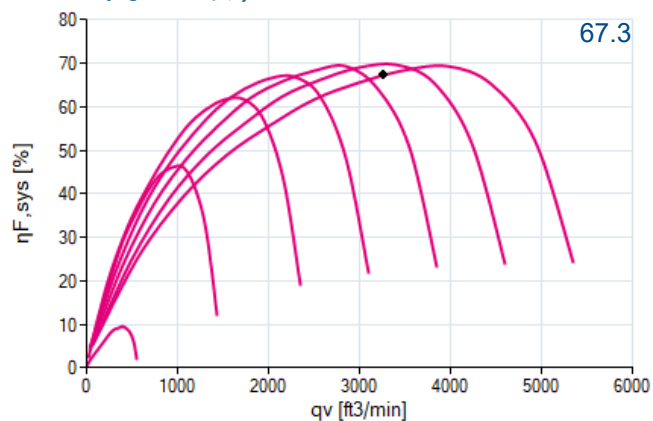

efficiency grade  $\eta_{SF,sys}$

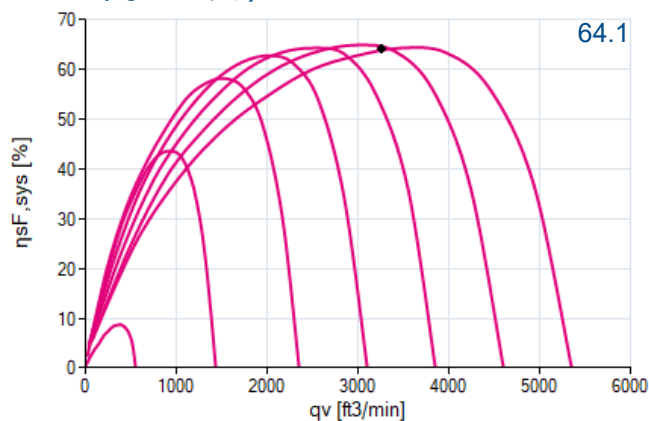

power input  $P_{sys}$

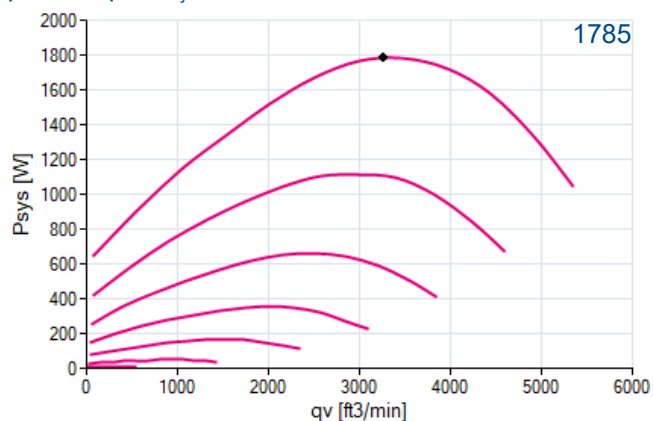



**nominal values** 15/12/2021  
 version FANselect V 1.01 (211209), AMCA V 1.03 September, 2021 / 1.21.12.09 | 53567 | (user ZAFS43567)



3~ 380-480V 50Hz P1 1.80kW  
 2.90-2.30A 1800/MIN 40°C  
 3~ 380-480V 60Hz P1 1.80kW  
 2.90-2.30A 1800/MIN 40°C  
 IP55 THCL155

**drawing** 15/12/2021  
 version FANselect V 1.01 (211209), AMCA V 1.03 September, 2021 / 1.21.12.09 | 53567 | (user ZAFS43567)

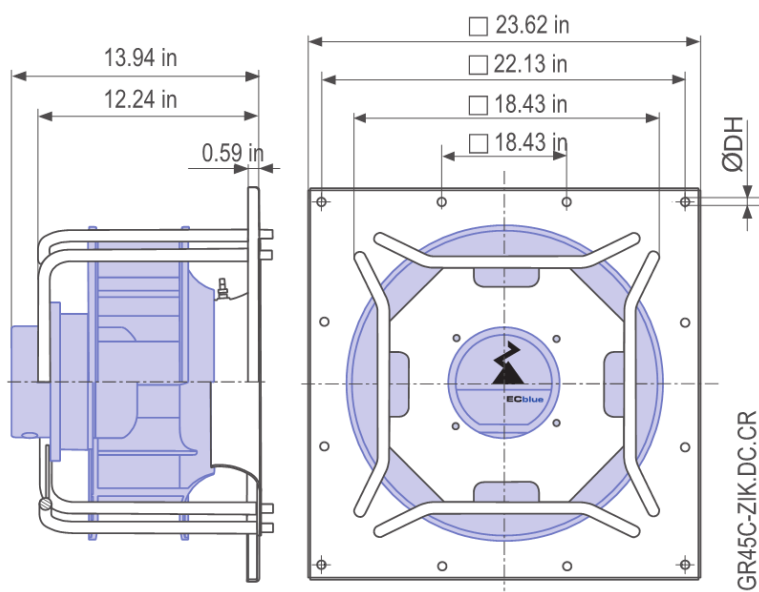

**wiring diagram** 15/12/2021  
 version FANselect V 1.01 (211209), AMCA V 1.03 September, 2021 / 1.21.12.09 | 53567 | (user ZAFS43567)

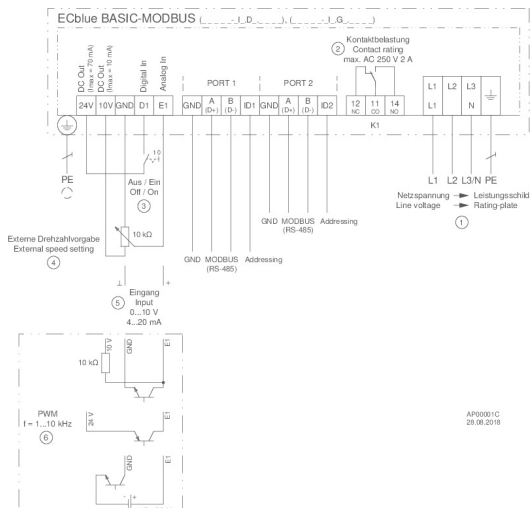



## system components

15/12/2021

version FANselect V 1.01 (211209), AMCA V 1.03 September, 2021 / 1.21.12.09 | 53567 | (user ZAFS43567)



type	GR45C-ZIK.DC.CR
article no.	116251/A01